

HOTEL



## Hotel

SECURITY AND DESIGN  
FOR YOUR COMFORT



**xpr**Home

# HOTEL SOLUTIONS

The **XPR HOTEL** solutions replace your old room keys with keyless access electronic systems by utilising Mifare Classic proximity and keycard technology.

Feel secure with this access control system technology that allows you to integrate all your and your guest's security needs into one stylish, modern and efficient installation.

The **XPR HOTEL** range includes 2 solutions for improving the security at hotels and B&Bs.

One includes a Mifare hotel Lock and the other one includes a flush-mount Mifare card reader. Both of them can be combined with a door bell button, an energy saver and a DND button.

In total, these are the main functions that can be done with these solutions:

- ▲ The hotel Lock Reader reads the room cards and release the door if card is valid.
- ▲ The outside LED Indicator gives light signal for clean room and do not disturb
- ▲ Touching the doorbell button will ring the bell.
- ▲ The energy saver detects presence of the card and enables the room electric system.
- ▲ The DND Button is used to set the "clean room" and the "do not disturb". Also it has a bell built-in.

## INSIDE

### FLUSH-MOUNTED SOLUTIONS



Energy saver + Room status selection, wall-mounted inside the room. (DINES + DND)



## OUTSIDE

### FLUSH-MOUNTED SOLUTIONS



Mifare Card Reader + Door Bell Button, wall-mounted outside the room. (DINMTPX-MF-SA + DINDB)



## OUTSIDE

### DOOR-MOUNTED SOLUTION

Hotel Lock reader, door-mounted outside the room. Configured to recognize the guests and the employees' cards. (HL-1000MF)



MIFARE READERS

WALL INSTALLATION

DINMTPX-MF-SA

Mifare Proximity Flush Mount Reader

The DINMTPX-MF-SA is a Mifare read/write reader. It can support Mifare Classic 1K and 4K memory. It has a memory that can hold 3500 events. It has a relay (2A) and a Micro-USB connection

Ref: DINMTPX-MF-SA-E

EASY PROGRAMMING

The configuration of the reader can be done by its built-in micro-USB port (located on the front of the pcb) or by programming cards.

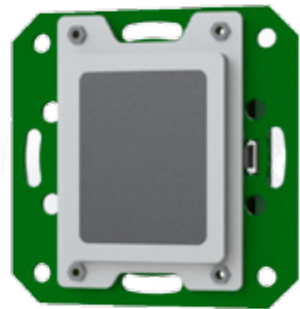

FLUSH MOUNT READER

It cannot be easier to complete any flush mount. Each piece matches perfectly with the next, and they can be installed in any standard electrical gang box. (The mask and the electronics are sold separately.) The mask is available in UK and European standards.

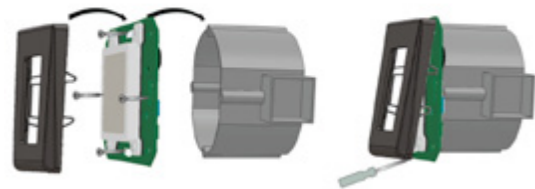

TRICOLOR STATUS LED

Fast and easy reading of the reader status.

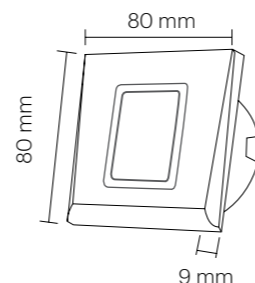

ABS mask colours

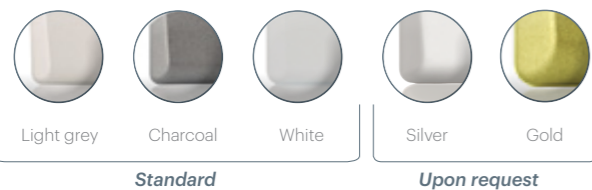

- 6 cm
- 20°C / +40°C
- 0% → 95%
- 9-14 VDC
- 40

MTPX-MF-SA

Mifare proximity reader

The MTPX-MF-SA is a Mifare read/write reader. It can support Mifare Classic 1K and 4K memory. It has a memory that can hold 3500 events. It has a relay (2A) and a Micro-USB connection.

Perfect for using it outdoors or in areas exposed to intense weather conditions. The housing is made of sturdy ABS.



- Silver
- Charcoal
- Black
- 6 cm
- 20°C / +50°C
- 0% → 95%
- 12VDC
- 1m
- 65

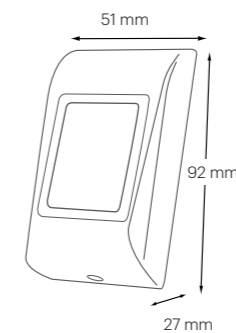

Ref: MTPXS-MF-SA / MTPXC-MF-SA / MTPXBK-MF-SA



HL1000-MF

Weather-proof Mifare Lock

HL1000-MF is a highly resistant weather-proof Mifare read/write reader. Made of stainless steel, it has a unique design with high sensitivity, being able to respond to Mifare proximity within a range of 3 cm distance.

It supports Mifare Classic 1K and 4K memory cards. It can store up to 3500 events in its memory and 500 cards in its blacklist, with unlimited user capacity.

It can be programmed by card, having 4 lock/unlock definable actions, based on the time and week of the day. It allows to put credit on card. The firmware can be upgraded by micro-USB, and it's compatible with our PROH-MS software.

Its power supply, which works with AA Alkaline batteries, has a long-life cycle of 12-18 months.



-20°C / +60°C



20% → 95%



Gold

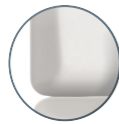

Silver



Ref: HL1000-MF

HL1000-MF LOCK DIMENSIONS

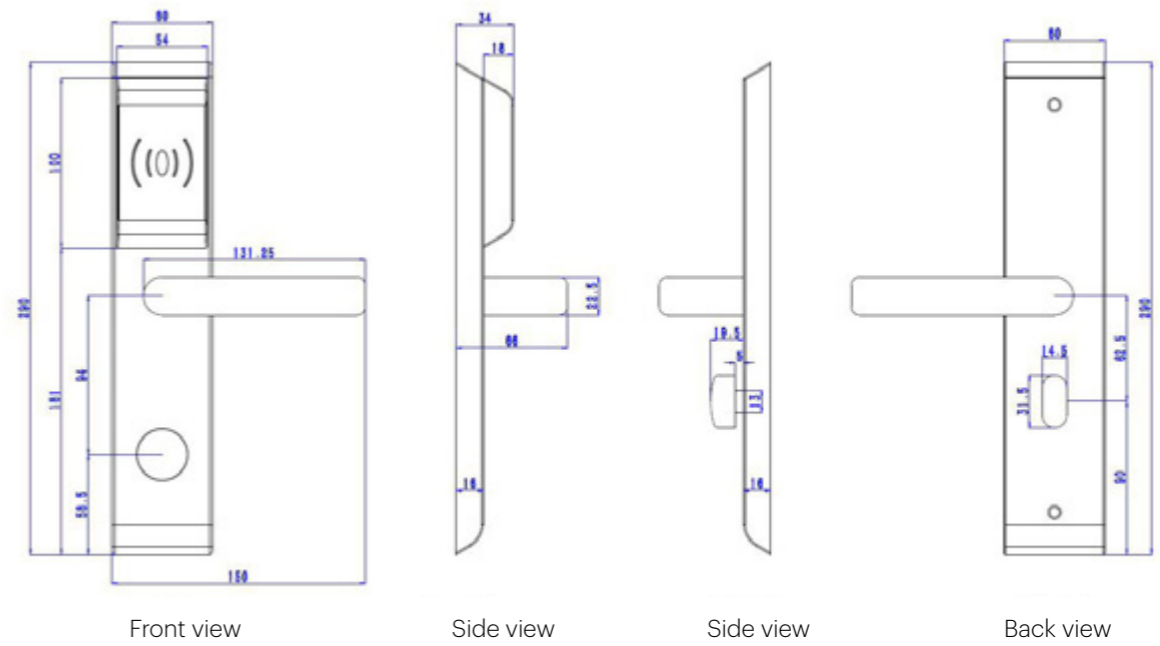

-20°C / +60°C



20% → 95%

Ref: AL500-MF

AL500-MF

Universal Mifare Lock

AL500-MF is the smaller and simpler of our Hotel Mifare Locks, with the advantage of being very easy to install and to use. It can be even installed without having to change your traditional door lock.

Ideal for employees, given them access to restricted areas like store rooms, kitchen, cleaning rooms, administrative rooms, and other areas...

Dimensions: 18 cm long, 4 cm wide.

# HOTEL ACCESSORIES

## WALL INSTALLATION

### INDICATOR - DINDB

#### Door Bell Indicator

DINDB is a DIN flush-mount door bell push button that can work in connection to other room indicators to make clear when the room is available, and when the guests prefer not to be bothered.

It has one transistor output for the doorbell and two inputs to connect it with the DND (Do not Disturb) and Clean buttons installed inside the room. The LED around the button indicates the status of the room.

Ref: DINDB-E



**RED LED**  
When the DND Button is switched on inside the room. The bell is off outside.



**GREEN LED**  
When the Make my room Button is switched on inside. The bell is on.

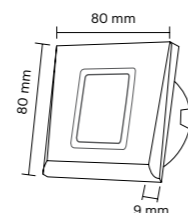

**GREEN LED BLINKING**  
When the bell is ringing.

-20°C / +40°C   
 12 VDC   
 IP 40  
 0% → 95%   



### DINMTPX-MF-SA + DINDB

#### Mifare reader + Door Bell Indicator

Mifare card reader (DINMTPX-MF-SA) + door bell button (DINDB), with all the characteristics described before, installed with the same double frame in ABS (FP2H).

Ref: DINMTPX-MF-SA-E + DINDB-E

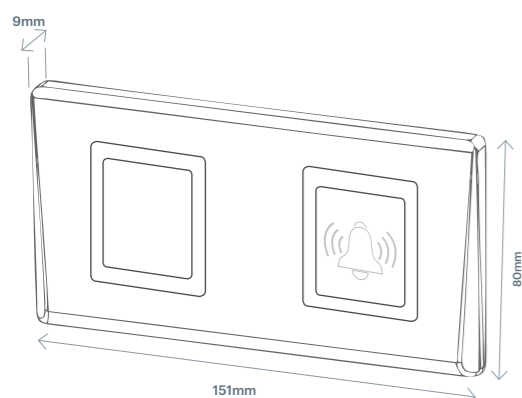

#### ABS mask colours

Light grey   
 Charcoal   
 White   
 Silver   
 Gold  
 Standard                      Upon request

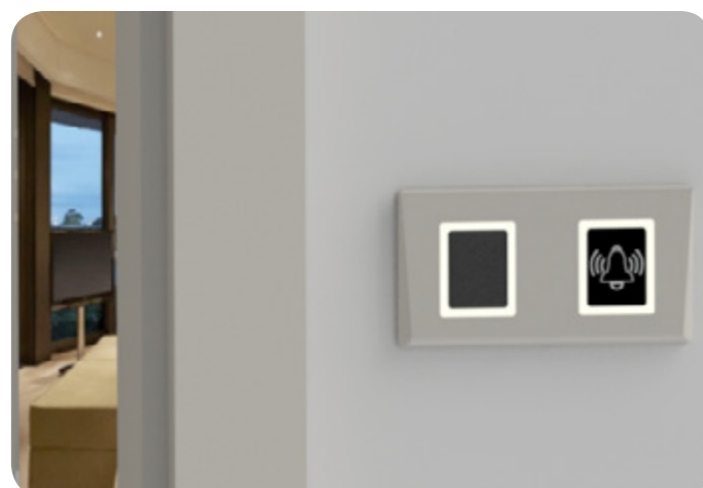

OUTSIDE



WALL INSTALLATION  
INSIDE



Symbols Legend

-   
Mifare
-   
Voltage
-   
Terminal Block
-   
Wiring
-   
Operating temperature
-   
Operating humidity
-   
IP Protection
-   
USB
-   
Micro-USB

WALL INSTALLATION

▲ DINES + DINDC

Energy saver (DINES) + Room status selection button (DINDC), with same double frame in ABS (FP2H).

The DINES can be either installed alone, or in combination with the room status button DINDC. See all their main characteristics below.







Ref. DINES-E + DINDC-E

▲ DINES

Flush Mount Energy Saver

The DINES is used as an energy saver reader with smart card holder. The contactless card reader will detect the guest MIFARE card only when placed in the card holder to activate/deactivate the energy in the room. It activates the power supply of the room and sends an order to the home automation central.

Ref. DINES-E

-  3 cm
-  0°C /+40°C
-  0% → 95%
-  12 VDC
-  40
-  40

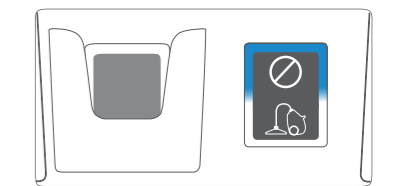





**BLUE LED ON TOP**  
When the DND button is switched on. Bell is off.

▲ DINDC

Flush Mount Room Status Button

The indicator works as a sensitive touch sensor button allowing the guest to change the room status required (Privacy or Do Not Disturb and Clean). This accessory could be installed as a single option or combined with the DINES energy saver reader in a vertical or horizontal front plate.

Ref. DINES-C

-  -20°C /+40°C
-  0% → 95%
-  9-14 VDC
-  40
-  40

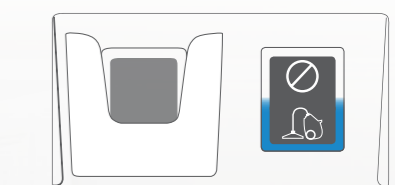
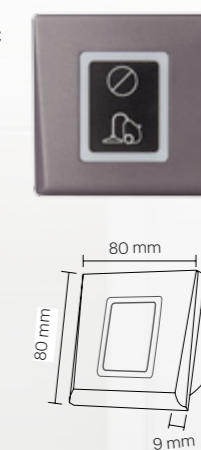

**BLUE LED AT THE BOTTOM**  
When the Make my room button is switched on. Bell is on.





IP 40

**PROX-USB**

Proximity desktop reader and enrolment unit

PROX-USB is an USB desktop proximity reader that enables easy card enrolment.\*

The PROX-USB doesn't need any installation or drivers. It's just USB powered. It comes with a large LED around the reader for an easy reading of the card enrolment.

\* It reads Mifare cards (ideal for the Offline Solution), but also EM and HID cards. So this product can be installed within other solutions as well.

Ref: PROX-USB

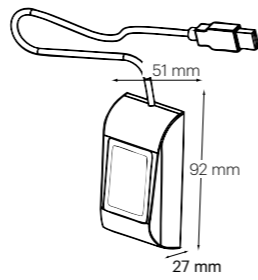

**MIFARE S50 & S70**

Fobs & Cards

The MIFARE contactless cards and keyfobs are available with 1 KB and 4 KB memory.

Different support are available: ISO and NISO cards and ABS key fobs. Key fob colors: grey, black, blue, red or green.

Ref: PBX-1E-MS 50/PBX-2-MS50/PBX-2C-MS50/PBZ-2-MS70



13.56 MHz



**DIN FRAMES**

Aesthetic ABS coloured frames for the DIN range electronics

These masks are available in single or double versions, vertical or horizontal, with and without energy saver holder.

Quick installation of the electronics by just pushing gently the frame into place, thanks to the clip mounting system.

Ref: DINFP/DINFP-UK/DINFP2H/DINFP2V/DINFP-ES/DINFP2H-ES/DINFP2V-ES

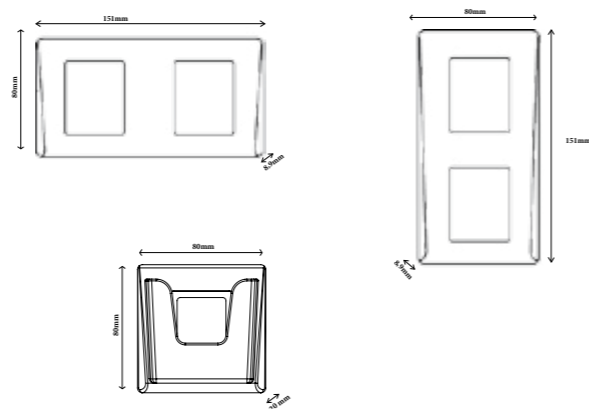

**ABS mask colours**

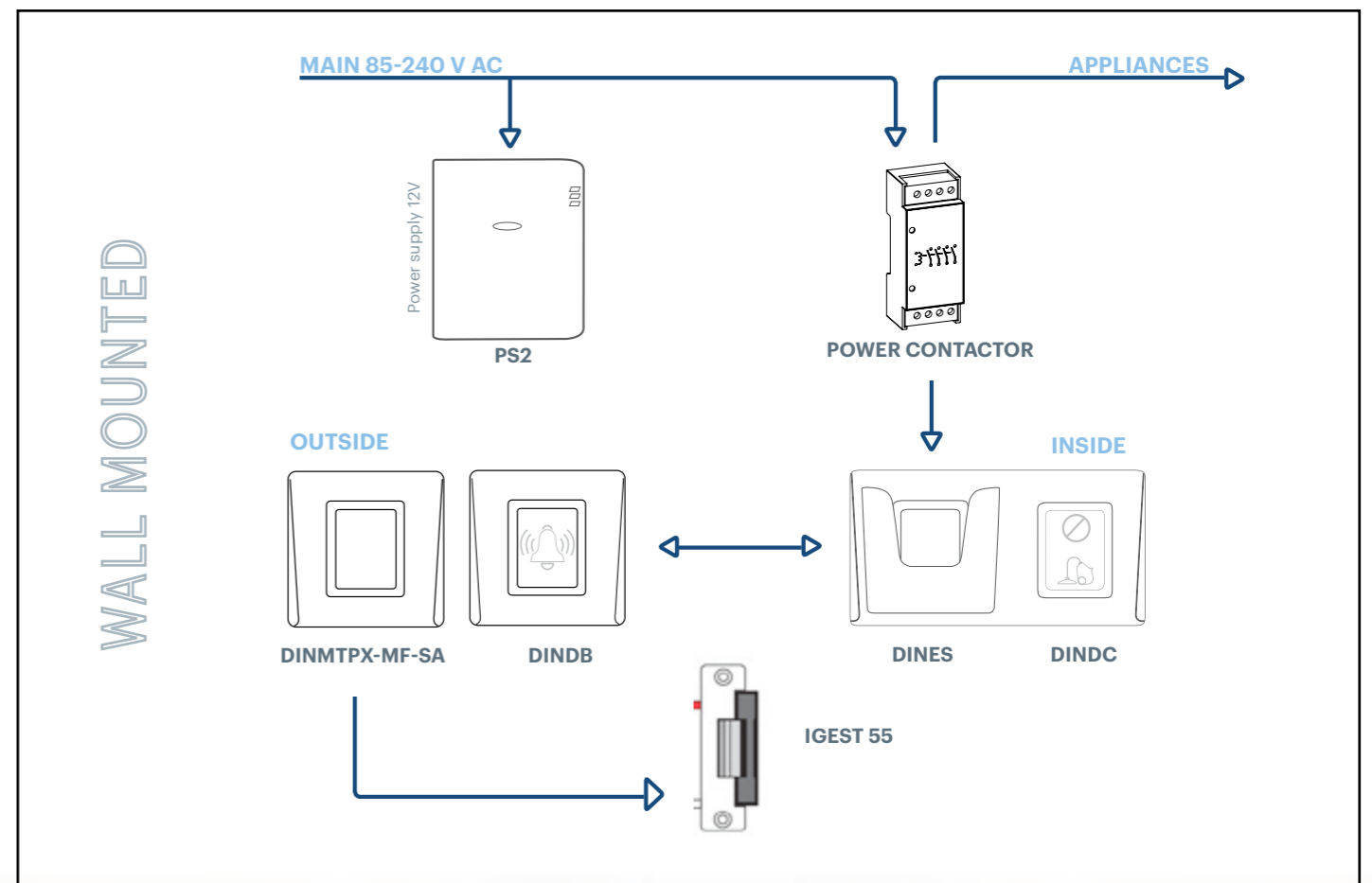
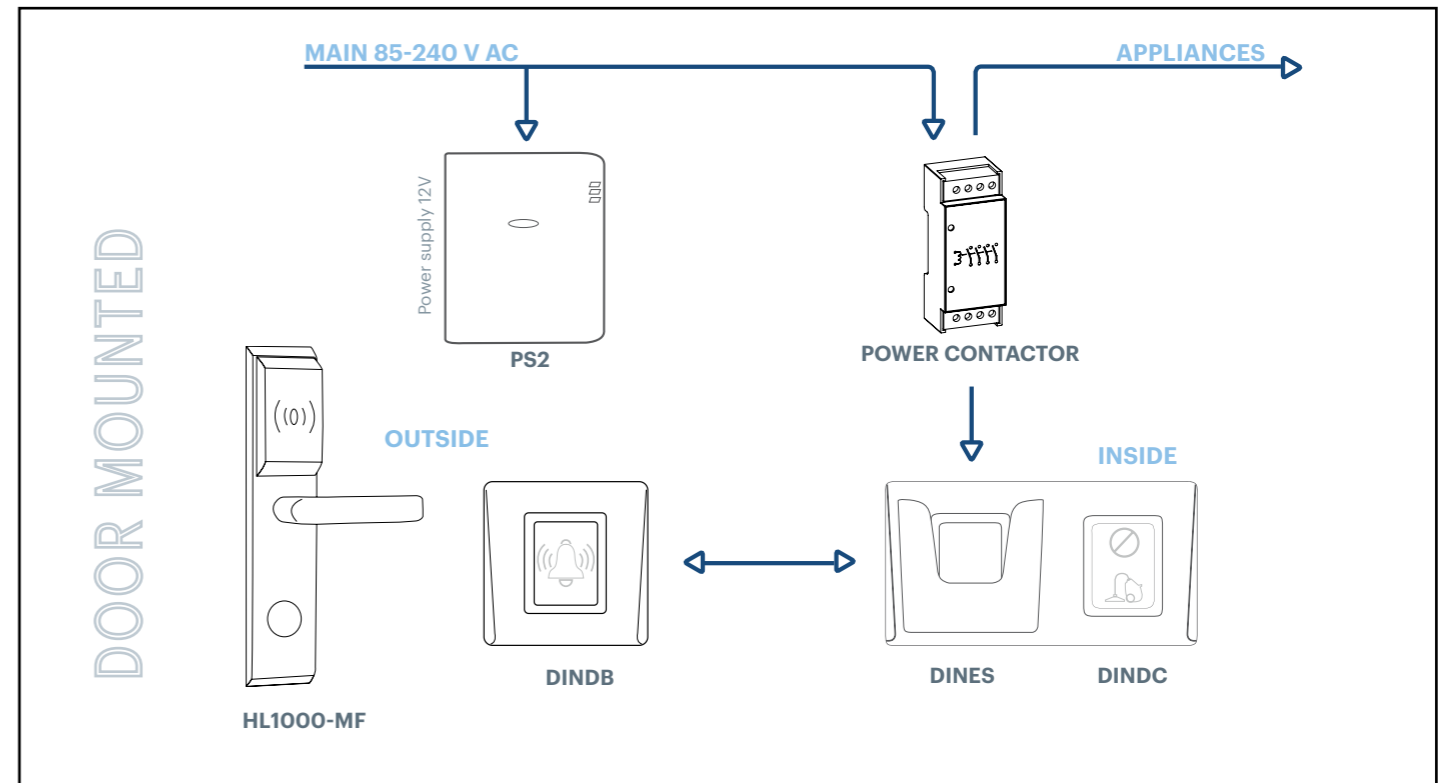
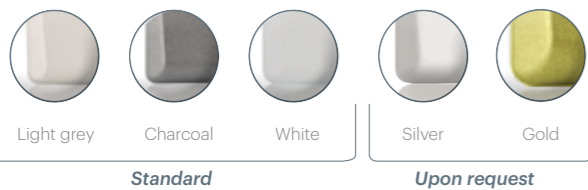

Following combinations are possible for usage where appropriate.

Application	Reader	Energy Saver	Indicator	DND	Power Contactor	Power Supply 12 V
Full system	X	X	X	X	X	X
Access control only	X					
Room power control for other power management systems (home automation)		X				X
Access control secure installation with power control for other power management systems (home automation)	X	X				X
Access control secure installation with power control	X	X			X	X
DND/Clean signalization for other systems			X			X
Standalone DND/Clean signalization and doorbell			X	X		X
Access control with DND/Clean signalization	X		X	X		X
Room power control for other power management systems, DND/Clean signalization and doorbell		X	X	X		X

### PROH MS (HOTEL MANAGEMENT SOFTWARE)

- ▲ Unlimited number of guest and employee cards
- ▲ Capacity: 255 Buildings, 255 Floors each, 223 Doors per Floor, 32 Public rooms
- ▲ Manage guests access to rooms and public rooms (Restaurant, Gym....)
- ▲ Manage employees access
- ▲ Cards enrollment via PROX-USB Desktop Reader
- ▲ SQL Database
- ▲ 32 Public Rooms Management (Swimming pool, Gym, Conference Hall...)
- ▲ Hotel Guest can have customized access to Public Rooms
- ▲ Visitors (not guests) can have access to Public Rooms defined by time, date, weekday and number of entries.
- ▲ The Software includes: Reservation, Check In, Reporting, Card issuing, Room service and Invoicing
- ▲ Reports for Check-ins, cards, events, bills...
- ▲ USB connectivity to the readers (locks included) for configuration and events download
- ▲ Public rooms automatic open/close schedule
- ▲ Compatible hardware:
  - PROX-USB desktop card reader/Writer
  - HL1000-MF Hotel lock
  - DINMTPX-MF-SA standalone reader
  - MTPX-MF-SA weatherproof standalone reader
- ▲ Client server software
- ▲ Multilanguage UK, FR, IT, ES, NL, DE.

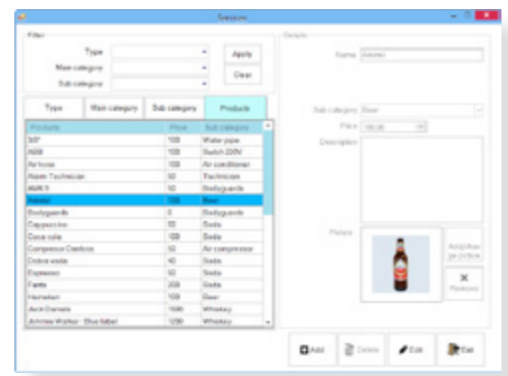

Clear visibility of the products for sale window.

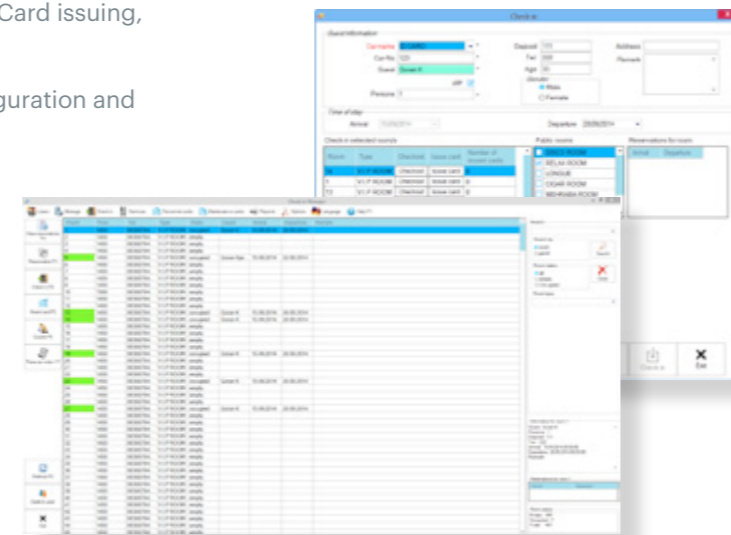

Easy to manage with the main control window.

ALL IN ONE SOFTWARE

HOTEL SOLUTIONS

- **MAIN HOTEL**  
Main window enable clear view of rooms status, guests, number of vacant rooms. Also enables quick search room name, status or guest. Simple interface make it easy to perform any operation like check in/out.
- **SERVICES ORDER-SERVICE PRODUCTS**  
Managing of the Guest orders and services make it easy to make final check out bill.
- **BOOKING**  
Make booking of any room for any period.
- **CHECK IN**  
Check in the guest and create room card.
- **PUBLIC ROOM**  
Restrict public rooms access to guests only. Rent public rooms for non guest usage.

 You can download the PROH MS software for free from our website:  
<http://www.xprgroup.com/products/proh-ms/>

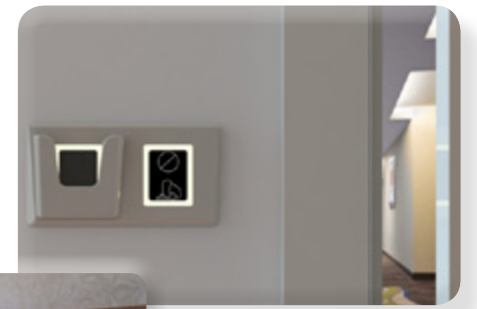
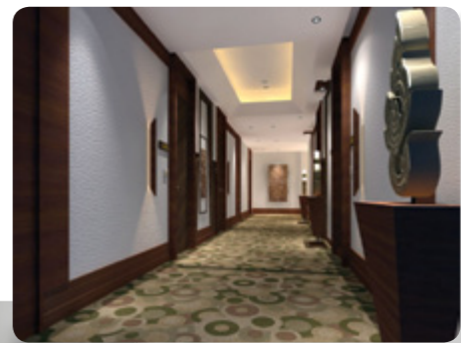



# HOME



**Find us on [www.xprgroup.com](http://www.xprgroup.com)**

We invite you to visit our website to obtain more information about our products.

