

SX-360Z is Listed to both UL and ULC.

SX-360ZV is not Listed to UL nor ULC.

FEATURES

- Ceiling Mount 360° PIR Detector
- Zoom Area Adjustment : ϕ 60ft Detection Area can be obtained at any installation height between 8 to 16ft. (ϕ 18m at H. 2.4 to 5.0m)
- High Density Detection Area with 276 zones.
- Selectable Sensitivity (High, Medium or Low)
- Selectable Pulse Count (1, 2 or 4)
- Initial Alarm Memory (SX-360ZV)
- LED Remote Control Terminal

I. INSTALLATION HINTS

<p>①</p> <p>Avoid direct sunlight.</p>	<p>②</p> <p>Avoid looking directly at air conditioning or heating vents.</p>	<p>③</p> <p>Avoid vapor or high humidity that can cause condensation.</p>
<p>④</p> <p>Avoid Curtain, Screen, etc. blocking detection area.</p>	<p>⑤</p> <p>Do not install outdoors.</p>	<p>⑥</p> <p>Install within 8~16ft (2.4~5m) height from floor.</p>

II. DETECTION AREA

TOP VIEW

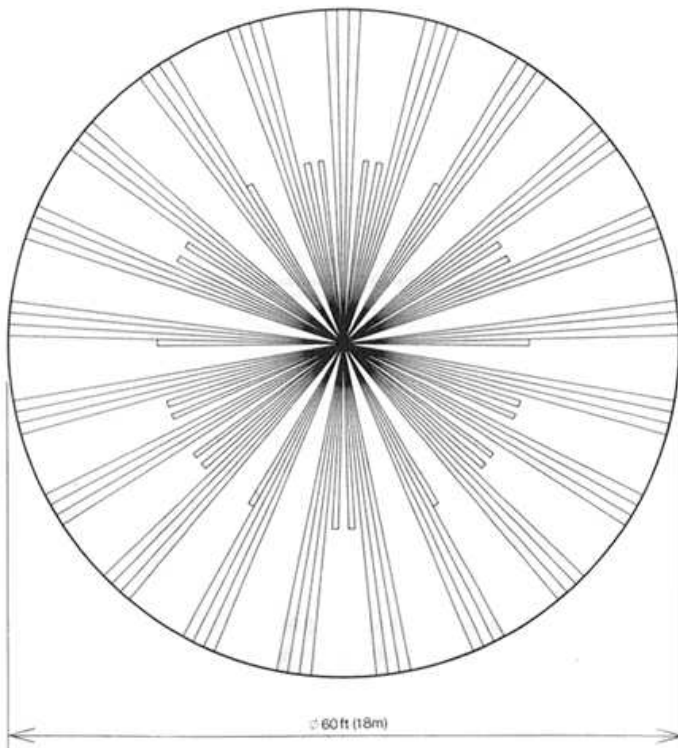

SIDE VIEW

ZOOM "A" Position (See Section VII.)

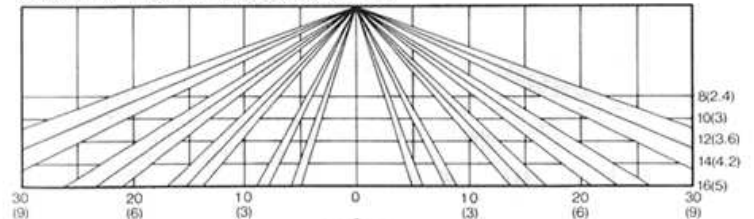

ZOOM "C" Position (See Section VII.)

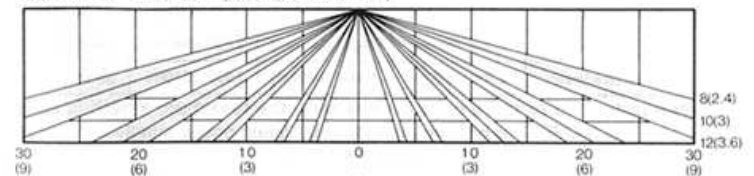

ZOOM "E" Position (See Section VII.)

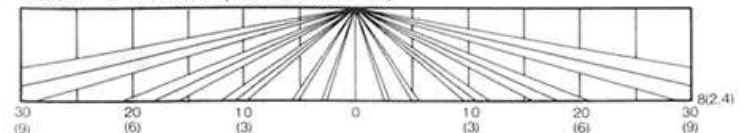

III. DESCRIPTION AND OPERATION

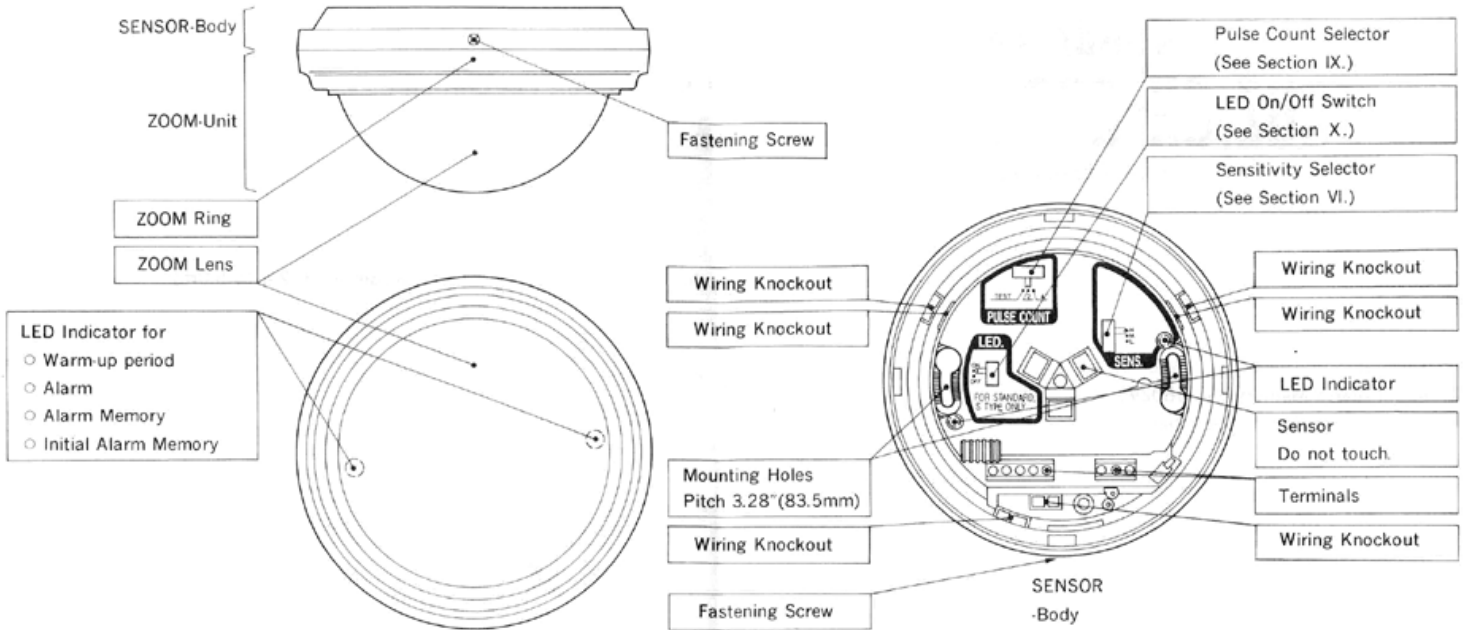

IV. INSTALLATION METHOD

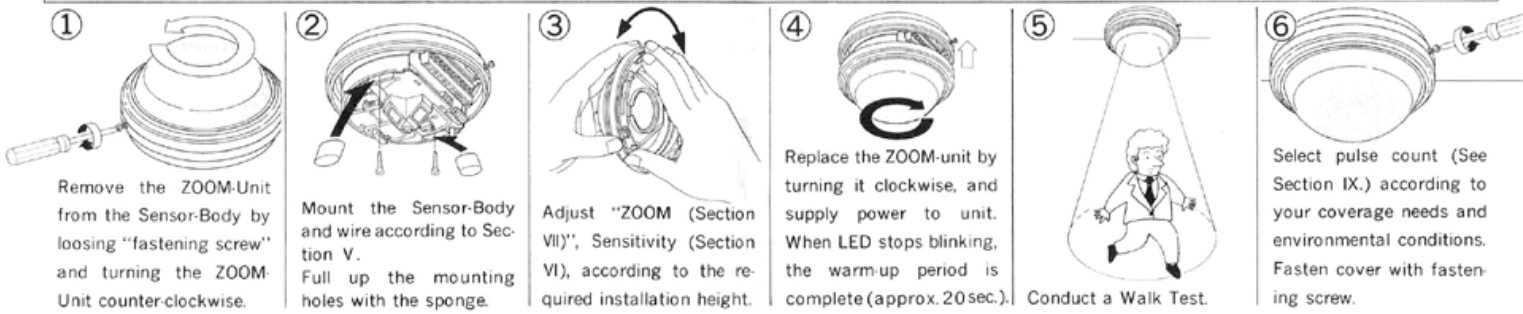

NOTE : When the warm-up period is over, alarm may be given once. This is an electric characteristic of SX-360Z and not a mal-function.

V. WIRING

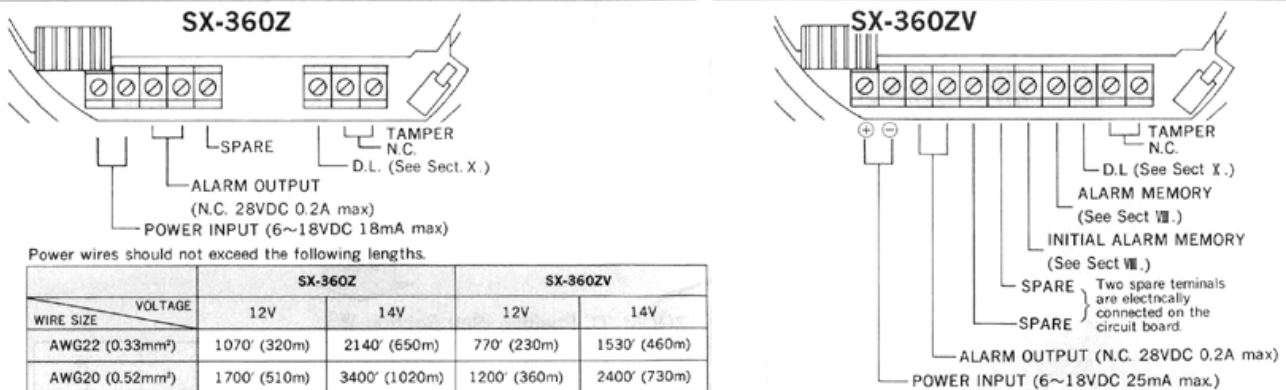

Power wires should not exceed the following lengths.

WIRE SIZE	SX-360Z		SX-360ZV	
	12V	14V	12V	14V
AWG22 (0.33mm ²)	1070' (320m)	2140' (650m)	770' (230m)	1530' (460m)
AWG20 (0.52mm ²)	1700' (510m)	3400' (1020m)	1200' (360m)	2400' (730m)
AWG18 (0.83mm ²)	2700' (820m)	5300' (1600m)	1900' (570m)	3800' (1150m)

- When using two or more units on one wire, the maximum length is obtained by dividing the above length by the number of units used.
- UL requires SX-360Z to be connected to a UL listed power supply capable of providing a nominal input of 12VDC (6~18VDC) 18mA(max.) [SX-360Z], and battery standby time of 4 hours.

VI. SENSITIVITY ADJUSTMENT

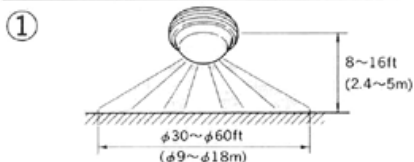

Before making adjustments, determine the mounting height and detection area. (See Section VII.)

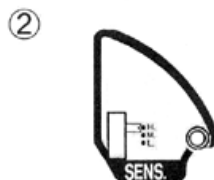

Select the sensitivity "H (High)", "M (Medium)" or "L (Low)". The following chart shows recommended setting for diameter of detection area.

SENS.	L	M	H
DIAMETER OF DETECTION AREA	φ30~φ40ft. (φ9~φ12m)	φ40~φ50ft. (φ12~φ15m)	φ50~φ60ft. (φ15~φ18m)

VII. ZOOM AREA ADJUSTMENT

The SX-360Z series detection pattern can be adjusted for installations at any height, between 8 to 16ft. (2.4~5m).

< DETECTION AREA CHART >

ft. (m)

MOUNTING HEIGHT	ZOOM LOCK SCREW	A	B	C	D	E
16ft. (4.8m)		φ60 (φ18)	---	---	---	---
14ft. (4.2m)		φ52 (φ16)	φ60 (φ18)	---	---	---
12ft. (3.6m)		φ45 (φ13)	φ50 (φ15)	φ60 (φ18)	---	---
10ft. (3m)		φ37 (φ11)	φ40 (φ13)	φ50 (φ15)	φ60 (φ18)	---
8ft. (2.4m)		φ30 (φ9)	φ34 (φ10)	φ40 (φ12)	φ48 (φ14)	φ60 (φ18)

< ADJUSTING THE ZOOM UNIT >

①

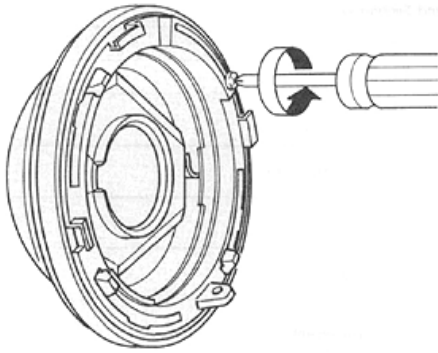

Loosen the black Zoom Lock screw.

②

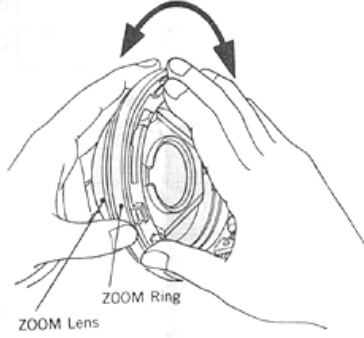

Turn ZOOM Ring for adjustment.
For higher installations, turn counter-clockwise.
For lower installations, turn clockwise.

③

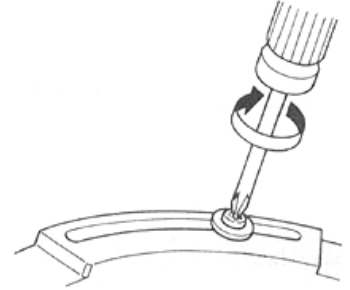

Fasten the black Zoom Lock screw at the marked point of the required installation height.
DON'T FASTEN THE SCREW TOO TIGHTLY.

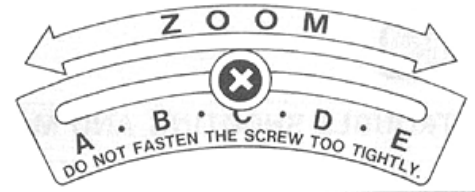

VIII. INITIAL ALARM MEMORY & ALARM MEMORY (SX-360ZV)

The SX-360ZV has an "initial alarm memory function." When several detectors are connected in one alarm loop, this function will indicate, by LED, memories which of the detectors was triggered first.

1. Wiring of Alarm Memory

Connect control voltage signal terminal of control panel to A.M. terminal.

	SX-360ZV
System armed	0~1VDC (grounded)
System disarmed	Open

"grounded" = AM terminal is electrically connected with ⊖ power supply terminal (ground).

2. Wiring of Initial Alarm Memory

Connect I.A. terminals of the detectors in one loop. (Parallel Connection)

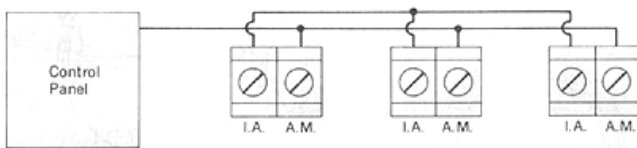

NOTE : Maximum 40 detectors can be connected in one loop for initial alarm memory.

3. LED Indications

If the unit is triggered during an armed period, when the system is disarmed, its LED condition will indicate that it reported the alarm.

★ When the initial alarm memory is used :

Initial alarm memory is indicated by a flickering LED. Other memories (from the second detection on) are indicated by a continuously lit LED.

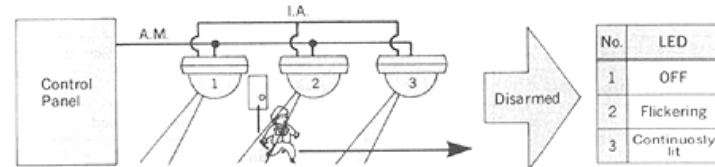

★ When the initial alarm memory is not used :

All alarm memories are indicated by flickering LED.

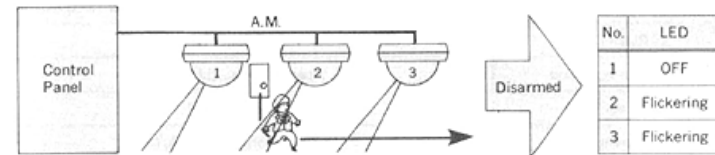

4. Reset

Alarm memory resets automatically when system is re-armed.

5. NOTES

Alarm Memory will operate whether the LED is disabled or not. Alarm Memory will not latch while system is disarmed. LED operation and alarm output are not affected by alarm memory when system is armed.

A compatible control panel is required for alarm memory.

IX. PULSE COUNT ADJUSTMENT



Adjust pulse count as follows.

- ★ Pulse Count 1 (Instant alarm mode)
Select this position for walk test only.

- ★ Pulse Count 2 (Standard position)
Select this position for most applications.
- ★ Pulse Count 4
For bad environments, changing temperatures etc.

X. LED ON-OFF

1. LED On/Off Switch (Models SX-360Z)



Use switch to enable or disable LED.

2. DL Terminal

★ Controls operation of LED only ; does not affect Alarm Memory function.

★ LED can be enabled/disabled remotely or at the detector.

	Remotely	At the Detector
LED Enabled	Connect DL terminal to common ground (with detector).	Connect ⊖ terminal of power input to DL terminal.
LED Disabled	No ground to DL terminal (open circuit).	No connection to DL terminal (open circuit).

XI. TROUBLE SHOOTING AND MAINTENANCE

PROBLEM	PROBABLE CAUSE	REMEDY
LED does not light	Incorrect power supply voltage (disconnection, or low voltage)	Correct supply voltage to 6~18V DC.
	Incorrect detection area.	See Section II and Section VII.
	Incorrect polarity to detector.	Switch positive and negative at terminal.
	LED switch is OFF	Turn on the Switch. See Section X.
LED lights even though no person within area.	Moving object within area. (curtain, wall hanging, etc.)	Remove object from detection area.
	Rapid temperature changes (heater, air-conditioner, etc.) within area.	Remove the sources from detection area.
LED continues to light	Poor connection of alarm memory. (SX-360ZV)	Reconnect wire.
	Wrong control voltage from panel. (SX-360ZV)	Must be 0~1VDC. (grounded)
LED lights but signal is not sent.	Relay contact is stuck or damaged due to overloading.	Check load of output. The unit needs repair or replacement.
	Faulty Wiring.	Wire correctly.

Conduct a walk test at least once per year.

XII. SPECIFICATIONS

Model	SX-360Z
Detection method	Passive Infrared
Coverage	∅60ft. (∅18m), 360° ZOOM
Detection zones	276 zones
Mounting	Ceiling : Height 8~16ft. (2.4~5m)
Sensitivity	3'F (1.6°C) at 2ft/sec. (0.6m/sec.) See Sect VI.
Detectable speed	1~6ft/sec. (0.3~1.8m/sec.)
LED indicator	LED is blinking during warm-up period.
	Alarm condition
Alarm period	2.0±0.5sec
Alarm output	N.C., 28VDC 0.2A(max)
Tamper switch	N.C., 30VDC 0.1A max. Opens when cover removed.
Pulse Count	20±5sec. 1,2or4
Warm up period	Approx 20sec. (LED blinks.)
Power input	6~18VDC
Current draw	13mA/(normal), 18mA/(max)
Weight	7.90oz. (224g)
Operating temperature	-4°F ~ +122°F (-20°C ~ +50°C)
Environment humidity	95%(max)
RF interference	No Alarm 30 V/m

V Version (Alarm Memory)	
Model	SX-360ZV
Alarm memory	Armed : 0 ~ 1VDC. See Sect. VIII.
Initial Alarm memory	Max.40 detectors See Section. VIII.
Current draw	13mA/(normal), 25mA/(max)
Weight	8.00oz. (227g)
RF interference	No Alarm 30V/m

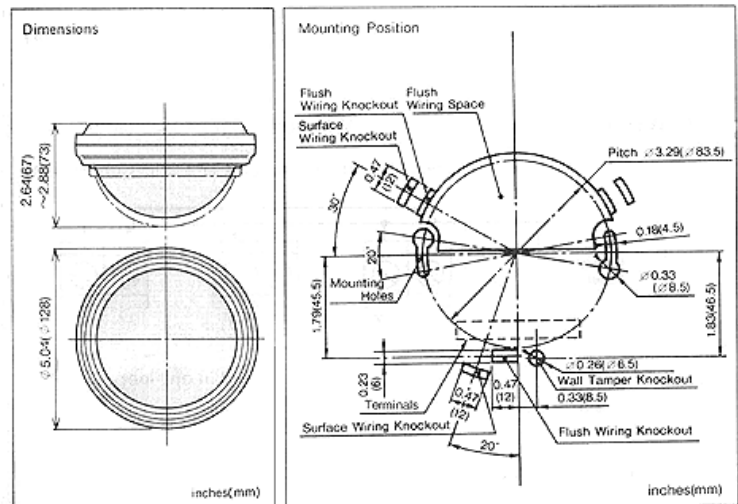

* Specifications and design are subject to change without prior notice.

NOTE

This unit is designed to detect movement of an intruder and activate an alarm control panel. Being only a part of a complete system, we cannot accept responsibility for any damages or other consequences resulting from an intrusion. This Product conforms to the EMC Directive, 89/336 EEC. The ULC products are installed in accordance with the Canadian Code as per Section 4.3 of ULC-S306.



OPTEX CO., LTD. (ISO 9001 Certified by LRQA, ISO 14001 Certified by JET)
5-8-12 Ogoto Otsu, Shiga, 520-0101 Japan
Tel : +81-77-579-8670 Fax : +81-77-579-8190
URL: <http://www.optex.co.jp>

OPTEX INCORPORATED
13661 Benson Ave., Bldg C Chino, CA 91710 U.S.A.
Tel : +1-909-993-5770 FAX : +1-909-628-5500
URL: <http://www.optexamerica.com>

OPTEX (EUROPE) LTD. (ISO 9001 Certified by NDA)
Civernon Road, Marconbad, Berkshire, SL6 7BU U.K.
Tel : +44-1628-631000 FAX : +44-1628-636311
<http://www.optex-europe.com>